

SECTION A-A

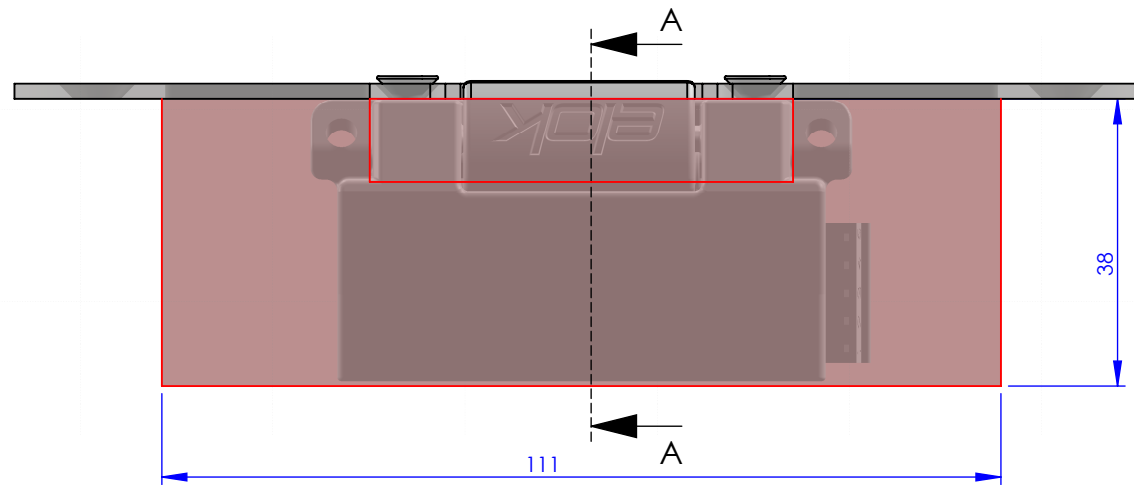
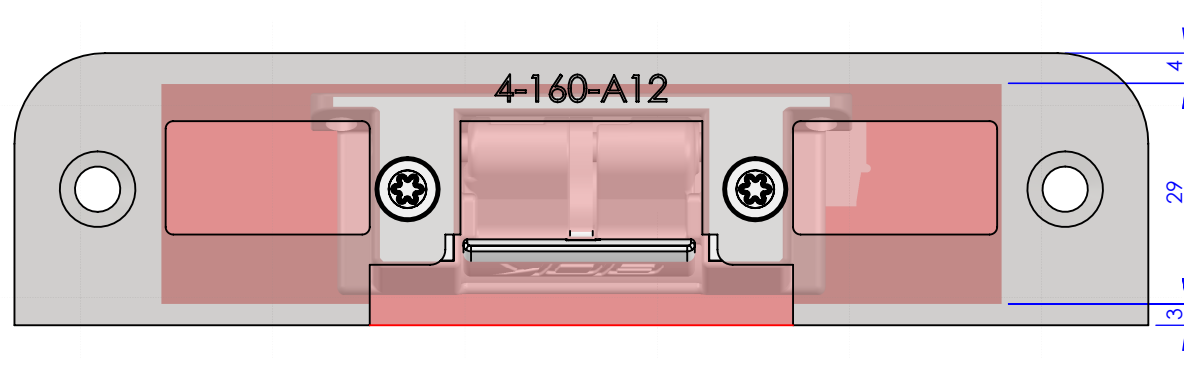
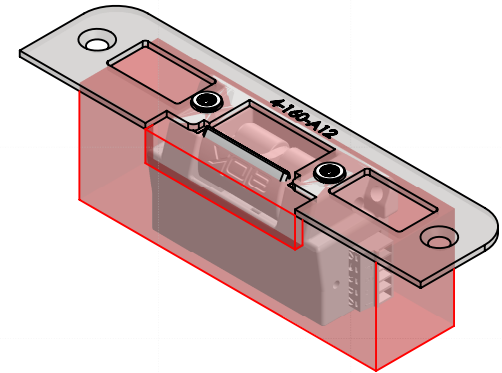
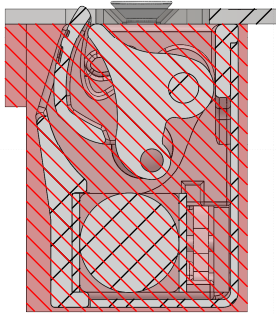

elok 4-160-A12 x WALK

Milling name: Faceplate

Comment: Electric strike ELOK WALK

Date: 28/01/2020

Scale: 1:1

Drawn by: MOF

Sheet: 1 (2)

Milling top view

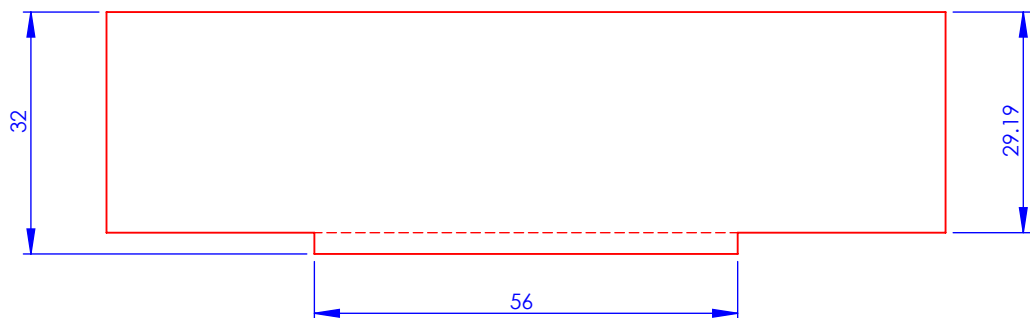

Milling front view

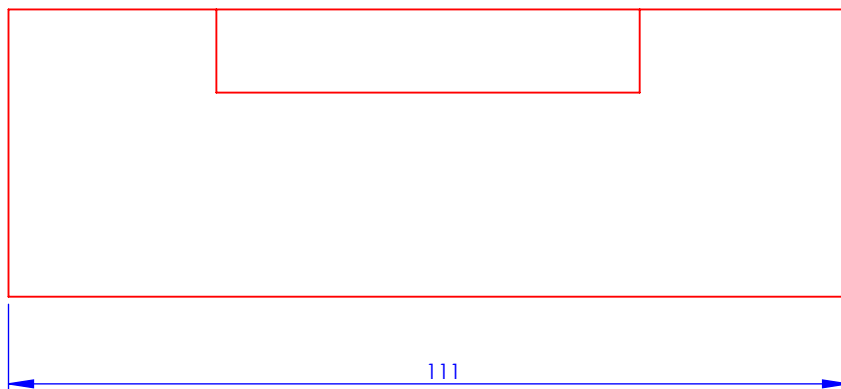

Milling side view

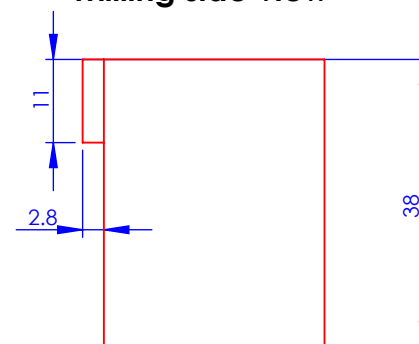

elok 4-160-A12 x WALK